

Lautsprecher LSM-57A Art.-Nr.: 120060

Specification :

TYPE	UNIT	LSM-57A
Impedance	Ω	8 \pm 15%
Power (Nominal)	W	0.25
Power (Maximum)	W	0.5
Resonant Frequency	Hz	450 \pm 20%
Sound Pressure Level	dB	85 \pm 3
Frequency Range	Hz	Fo~4.000
Operating Temperature	$^{\circ}$ C	-20~+60
Storage Temperature	$^{\circ}$ C	-30~+70

Dimensions :

(Unit : mm)

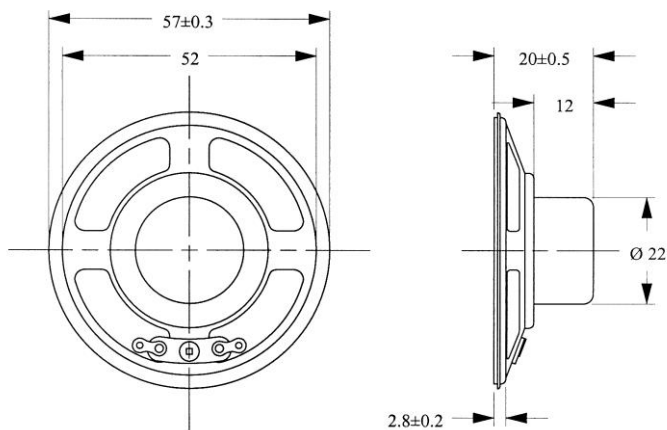

Frequency Response :

